

# Schema explodata Masina de taiat asfalt beton MTA 501

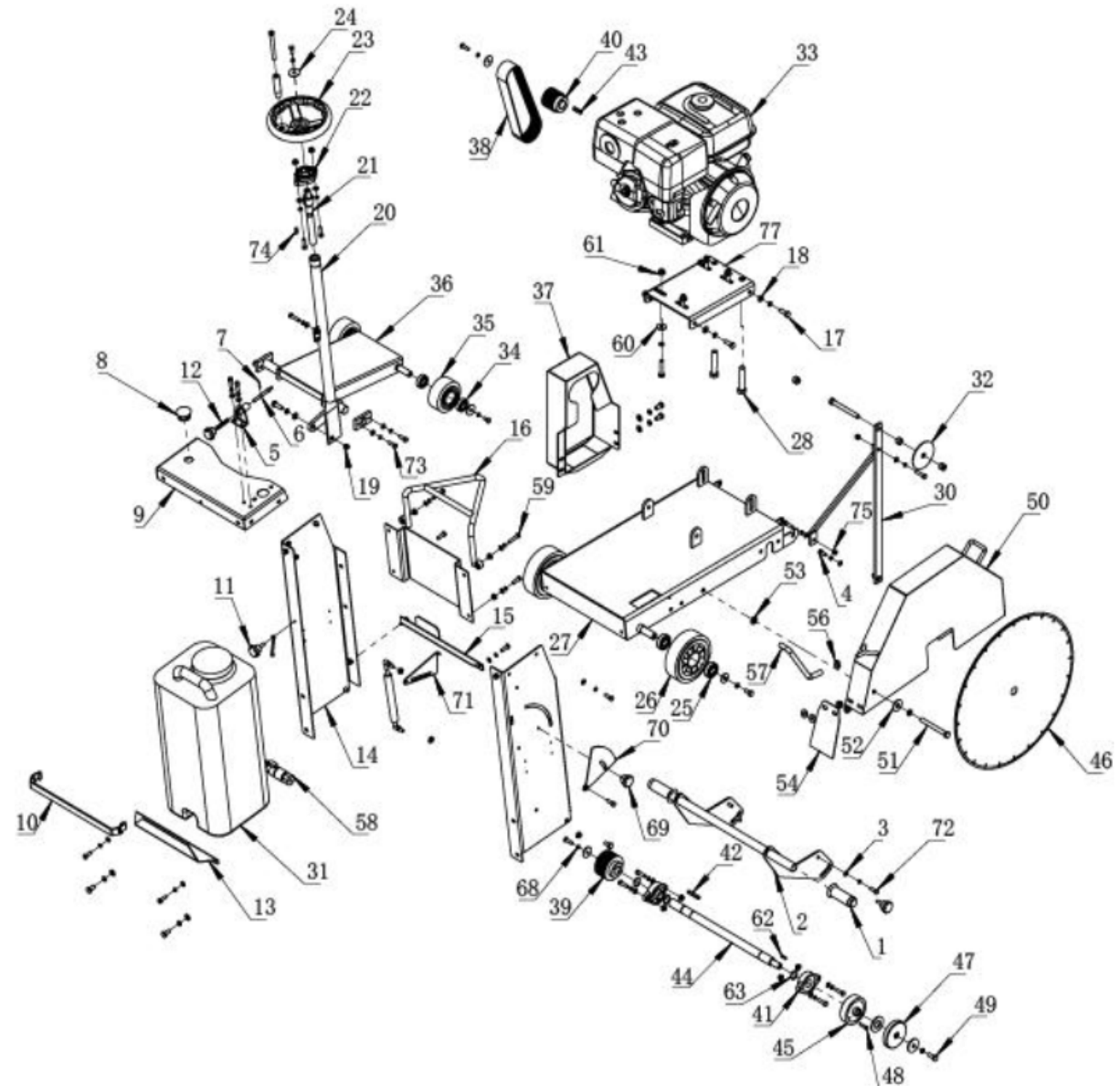









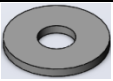

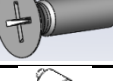
PART NO.	Image	DESCRIPTION	Quantity
1		Handle grip	2
2		Handle (set)	1
3		Flat washer M8	32
4		Screw M8*20	36
5		Lock system	1
6		Lock pin	1
7		Lock pin	1
8		Switch, emergency stop	1
9		Cover of water tank	1
10		Bandage	1
11		Clamping knob M8	1
12		Spring	1
13		Rear support plate for water tank	1
14-1		Left side plate for water tank	1
14-2		Right side plate for water tank	1
15		Front support plate for water tank	1

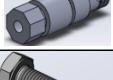
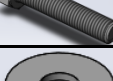
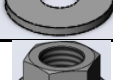

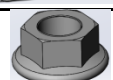
16		Lifting hook	1
17		Screw M10*30	1
18		Flat washerφ10	1
19		Locknut M10	3
20		Jackpost assy.	1
21		Jackscrew	1
22		Bearing LF204	1
23		Wheel	1
24		Bigger flat washer φ8	7
25		Bearing for real shaft	4
26		Rear wheel	2
27		Base plate	1
28		Screw M8*90	1
29		Nut M8	6
30		Pointer arm	1
31		Water tank	1
32		Pointer wheel	1
33		Engine	1

34		Bearing for front wheel	4
35		Front wheel	2
36		Wheel rack module	1
37		Belt cover	1
38		Belt	2
39		Pulley, driven	1
40		Pulley,engine	1
41		Bearing seat LF205	2
42		Flat key for main shaft 8x7x20	1
43		Flat key for driving pulley 7x7x25	1
44		Main shaft	1
45		Blade flange (inner)	1
46		Blade	1
47		Blade flange(outer)	1
48		Screw	1
49		Screw M12X30	1
50		Blade cover	1
51		Screw M12X100	1

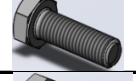
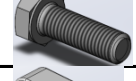
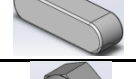
52		Washer M12	2
53		Nylon washer M12	1
54		Rubber mat	1
55		Screw M6x16	2
56		Clamp	2
57		Water pipe	1
58		Cock 1/2	1
59		Screw M10X45	4
60		Bigger flat washer φ10	4
61		Washer M10	4
62		Key 5x5x20	1
63		Circlip φ25	3
64		Spring washer M8	7
65		Plate for wheel rack module	2
66		Socket head bolt M8x30	1
67		Bolt M8	
68		Front guard for water tank	1
69		Clamping knob M8x10	1

70		Outer indicator	1
71		Inner indicator	1
72		Hex bolt M8x30	1
73		Hex bolt M8x25	6
74		Flat key 6x6x25	1
75		Locknut M8	3
76		Switch cable for emergency stop	1
77		Base assy..engine	1
78		Pneumatic rod	1

**MAXJONEL SRL**  
**CUI: RO21803460; J28/418/2007**  
**Str. Fratii Buzesti, 76A, Bals, judet Olt, 235100**  
**Comenzi: 0741 499 499 - 0757 101 819;**  
**Piese schimb: 0785 850 961**  
**comenzi@maxjonel.ro; [www.maxjonel.ro](http://www.maxjonel.ro)**